

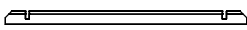



	Ref.	L	Index	#
	A WW019x067-DEM-000-1-	1180	2	
	B WW019x056-FEM-IF1-1-	1180	2	
	C WW019x123-2IF-000-1-	1180	4	
	D WW019x112-2IF-IF1-1-	1180	2	
	E WW028x028-IF1-000-1-	999	2	
	F WW028x028-IF2-000-1-	999	2	
	G S5220		1	

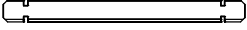
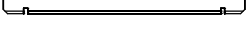

S7273

PO _____

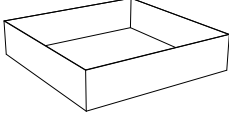
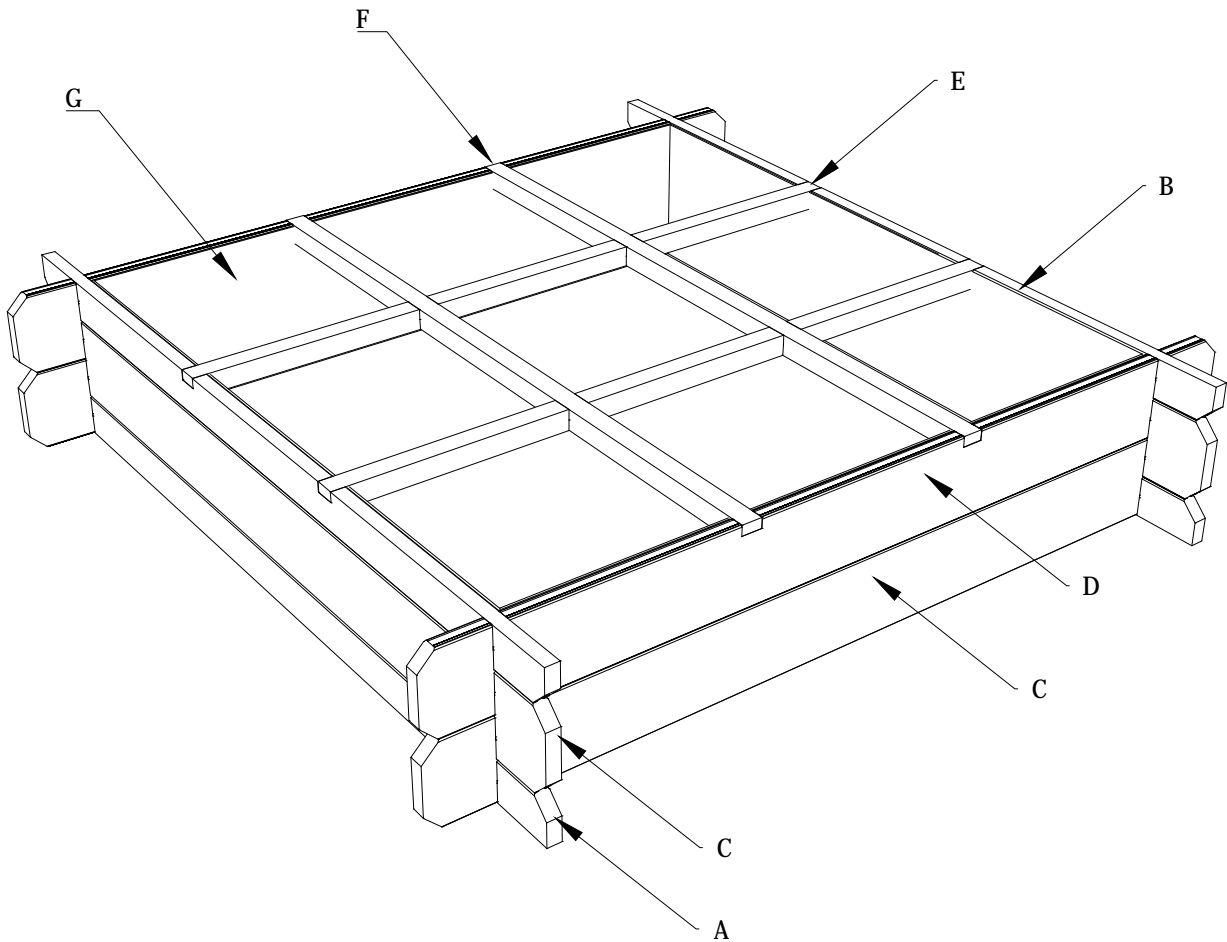
Winkel / Magasin / Store / :

Klant / Cliënt / Client / :
Adres:

Verantwoordelijke / Responsable

fl