

Ø8 mm

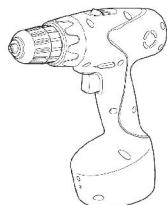

Ø3 mm

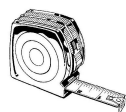
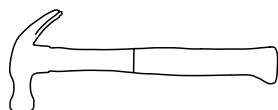

Ø12 mm
Ø8 mm

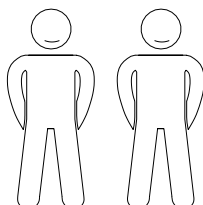
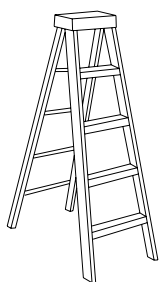



Les dimensions données sur le plan de soubassement sont les dimensions de la dalle béton à réaliser sur un sol parfaitement plat sans aucun autre objet extérieur type mur, clôture ou arbre dans l'entourage de la dalle. Si le produit est implanté près d'un mur, d'une haie ou d'un arbre il est nécessaire de l'éloigner des éléments extérieurs afin de pouvoir facilement le monter et l'entretenir. Nous nous dégageons de toute responsabilité en cas de mauvaise interprétation des dimensions de la dalle.

Le dimensioni del piano di base sono le dimensioni della soletta di cemento da realizzare su un terreno perfettamente piatto, senza alcun altro oggetto esterno, come un muro, una recinzione o un albero in prossimità delle solette. Se il prodotto è installato vicino ad una parete, un recinto o un albero, è necessario distanziarlo adeguatamente, in modo da poterlo facilmente montare e farne la manutenzione. Non ci assumiamo alcuna responsabilità per l'errata interpretazione delle dimensioni delle lastra.

NOTICE DE MONTAGE du THERMABRI
Réf. THE2420.02T

Nous garantissons la fourniture des pièces détachées durant 2 ans à compter de l'achat du produit.
Vérifier que vous avez bien toutes les pièces avant d'effectuer le montage

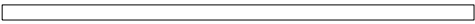
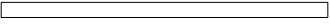
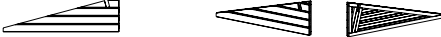
Demande sav

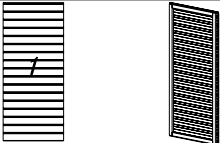
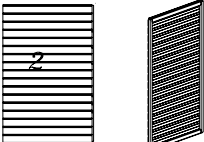
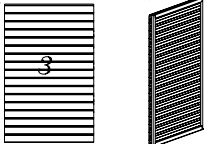
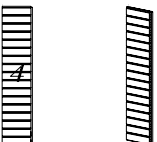
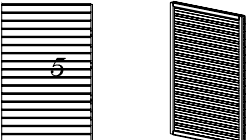
Réf.	Qté.	Dessin pièce	Dimensions (en mm)			Observation	Qté.
1	2		95	38	2320		
2	2		95	38	1770		
3	2		355	49	1130		
4	2		355	49	1130		
5	1		800	49	1829		
6	1		1200	49	1829		
7	1		1180	49	1829		
8	1		390	49	1829		
9	1		1180	49	1829		

**A compléter impérativement pour toute demande SAV et à envoyer par mail à
sav@foresta.fr + photo des pièces abîmées**

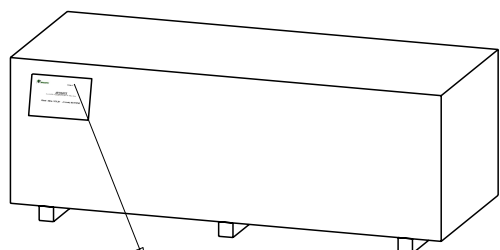

Colis n°: _____

THE2420.02T

Colis n°: _____



NOM DU MAGASIN
(où l'abri a été acheté)

NOM DU CLIENT

PRENOM DU CLIENT

N° de téléphone

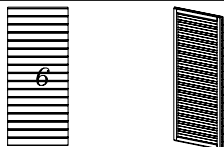
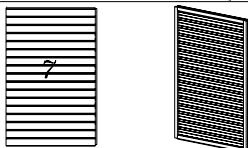
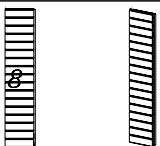
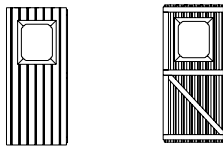
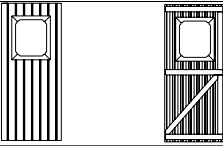
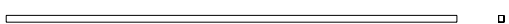
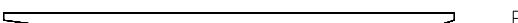
NOTICE DE MONTAGE du THERMABRI
Réf. THE2420.02T

						Demande sav	
Réf.	Qté.	Dessin pièce	Dimensions (en mm)			Observation	Qté.
10	1		800	49	1829		
11	1		11800	49	1829		
12	1		390	49	1829		
13	1		792	38	1815		
14	1		792	38	1815		
15	2		30	45	2480		
16	2		95	45	2480		
17	2		466	12	356		
d1	4		117	19	1426		

A compléter impérativement pour toute demande SAV et à envoyer par mail à
sav@foresta.fr + photo des pièces abîmées

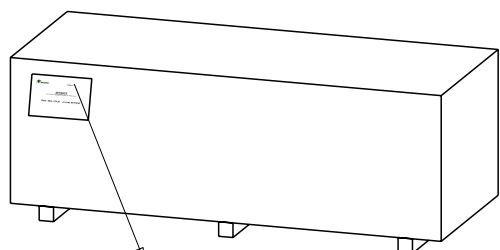

Colis n°: _____

THE2420.02T

Colis n°: _____









NOM DU MAGASIN
(où l'abri a été acheté)

NOM DU CLIENT

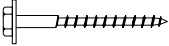
PRENOM DU CLIENT

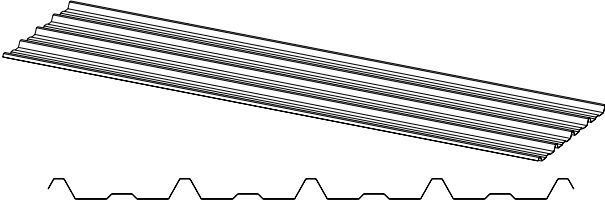
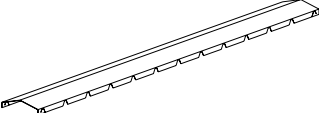
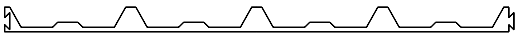
N° de téléphone

NOTICE DE MONTAGE du THERMABRI
Réf. THE2420.02T

					Demande sav		
Réf.	Qté.	Dessin pièce	Dimensions (en mm)			Observation	Qté.
q1	14			ø 8	110		
q2	95			ø 5	80		
q3	90			ø 4	40		
q4	44			ø6.5	100		
q5	44		38	12	40		
q6	50			ø4.8	20		
q7	6		1000	40	1400		
q8	2						
q9	6						
q10	10			ø 3.5	30		
q11	6						
q12	1						
q13	2						

A compléter impérativement pour toute demande SAV et à envoyer par mail à sav@foresta.fr + photo des pièces abîmées

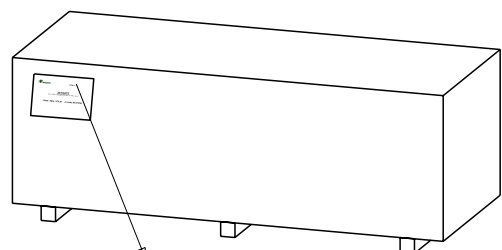

Colis n°: _____

THE2420.02T

Colis n°: _____

NOM DU MAGASIN
(où l'abri a été acheté)

NOM DU CLIENT

PRENOM DU CLIENT

N° de téléphone

Plan de soubassement

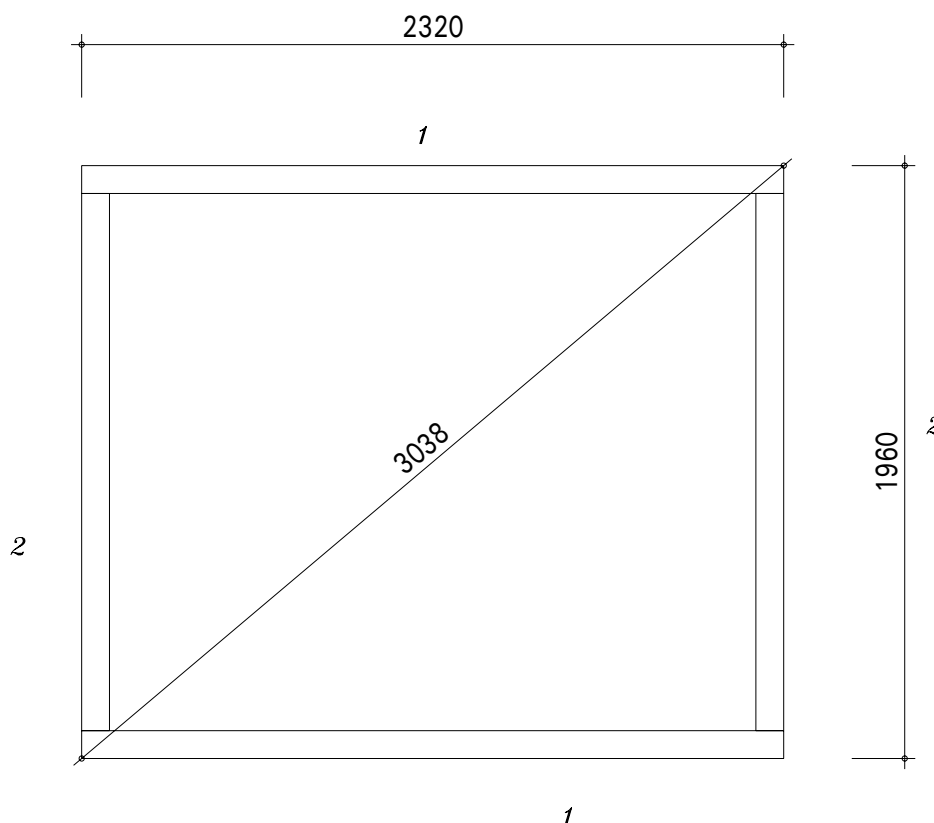

Les dimensions données sur le plan de soubassement sont les dimensions de la dalle béton à réaliser sur un sol parfaitement plat sans aucun autre objet extérieur type mur, clôture ou arbre dans l'entourage de la dalle. Si le produit est implanté près d'un mur, d'une haie ou d'un arbre il est nécessaire de l'éloigner des éléments extérieurs afin de pouvoir facilement le monter et l'entretenir. Nous nous dégageons de toute responsabilité en cas de mauvaise interprétation des dimensions de la dalle.

Le dimensioni del piano di base sono le dimensioni della soletta di cemento da realizzare su un terreno perfettamente piatto, senza alcun altro oggetto esterno, come un muro, una recinzione o un albero in prossimità delle soletta. Se il prodotto è installato vicino ad una parete, un recinto o un albero, è necessario distanziarlo adeguatamente, in modo da poterlo facilmente montare e farne la manutenzione. Non ci assumiamo alcuna responsabilità per l'errata interpretazione delle dimensioni delle lastra.



q1

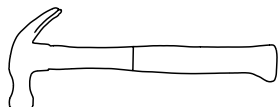

 $\varnothing 8$ mm

Tolérances à respecter (selon DTU 31.2):

- longueur et largeur: $\pm 0,01$ m;
- équerage: $\pm 0,01$ m mesuré sur 10m;
- arase: $\pm 0,01$ m sur une longueur de 10 mètres linéaires alignés ou non et de ± 2 mm par mètre linéaire;
- rectitude de bords en plan: ± 5 mm .

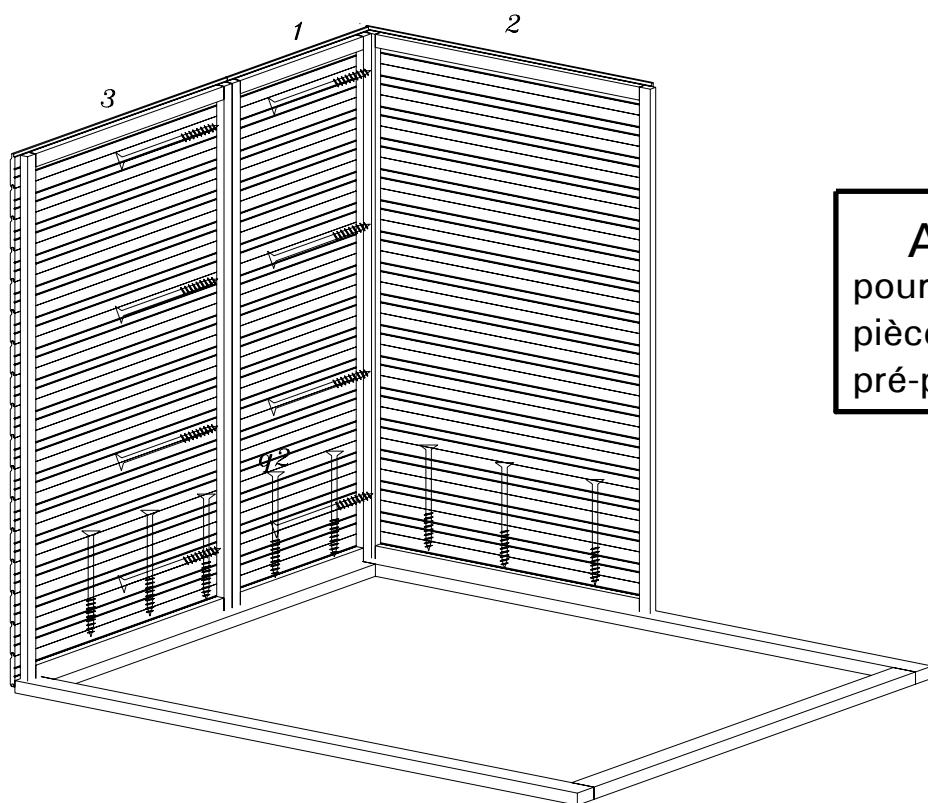

ATTENTION!!!.
pour éviter d'abimer vos
pièces de bois, il faut les
pré-percer avant de visser

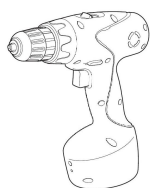
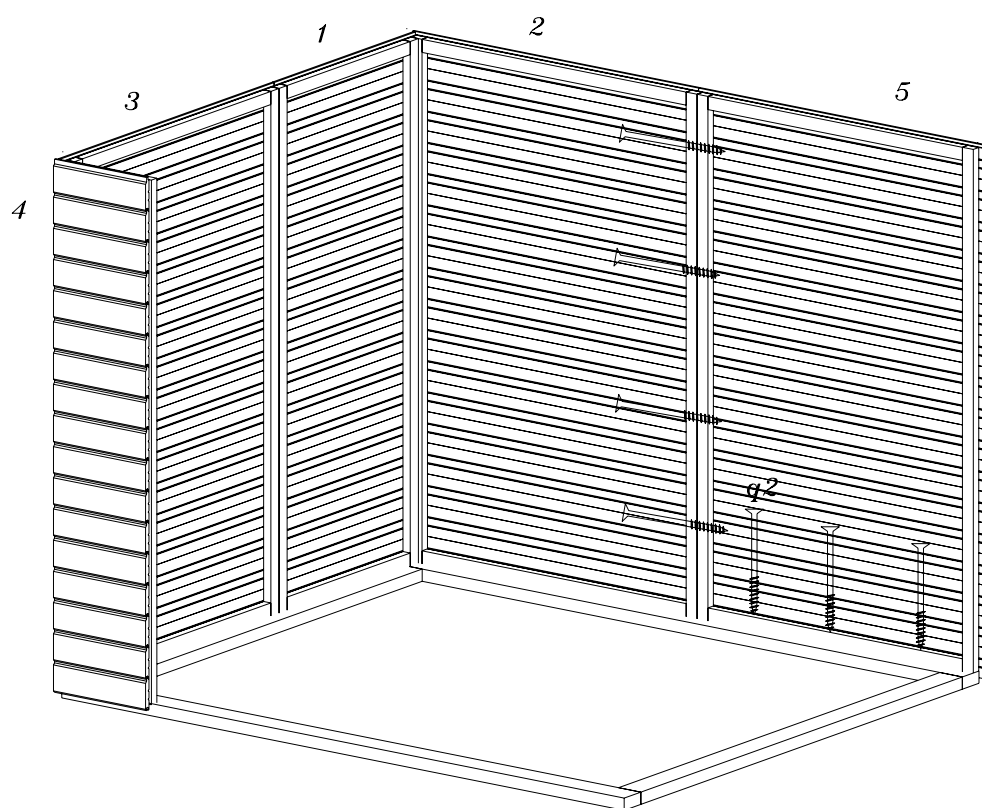

Ø3 mm



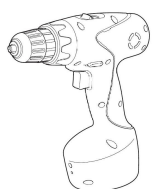
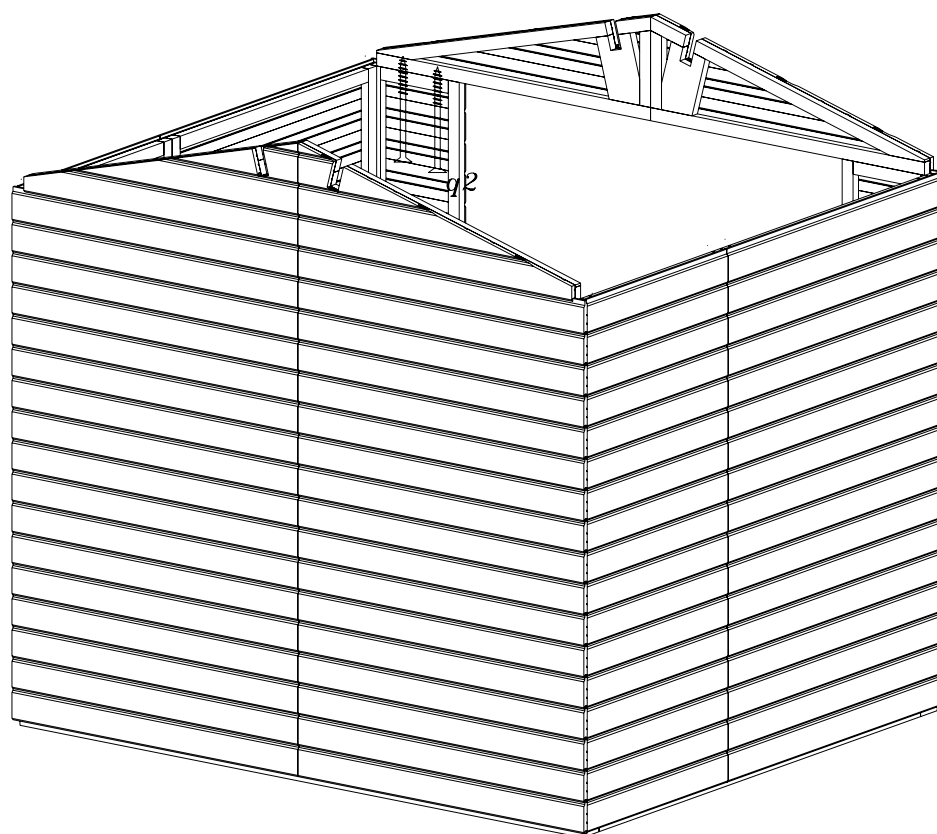
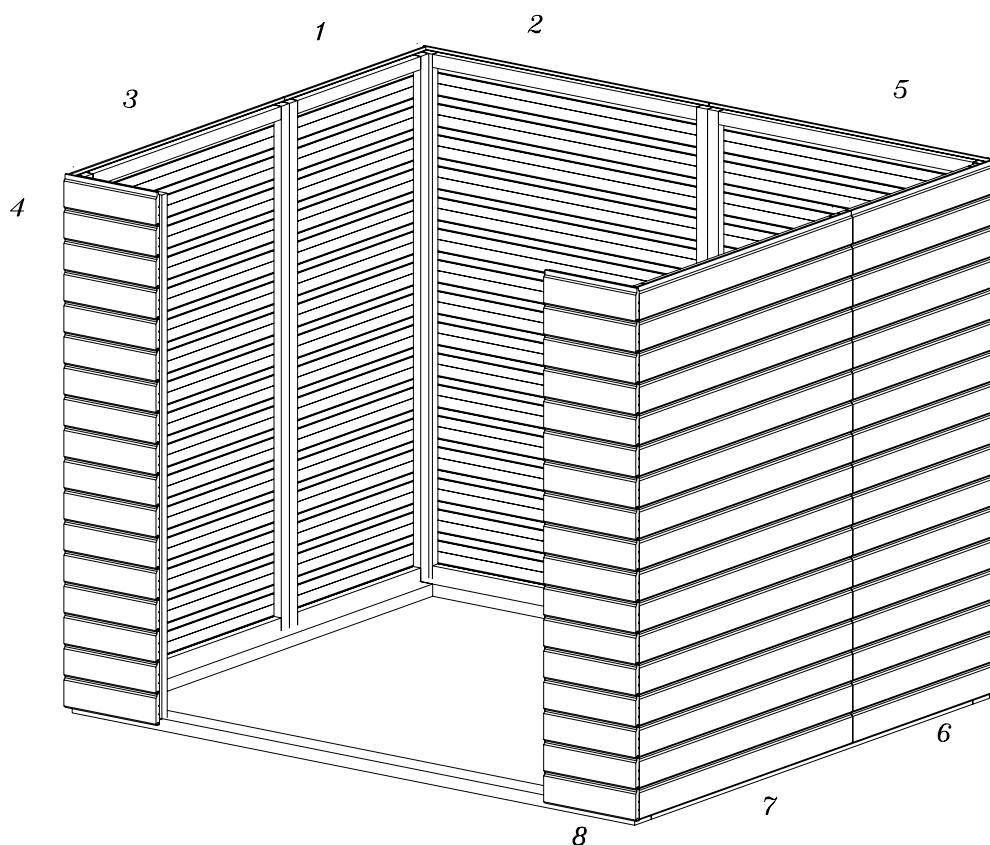

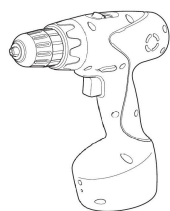
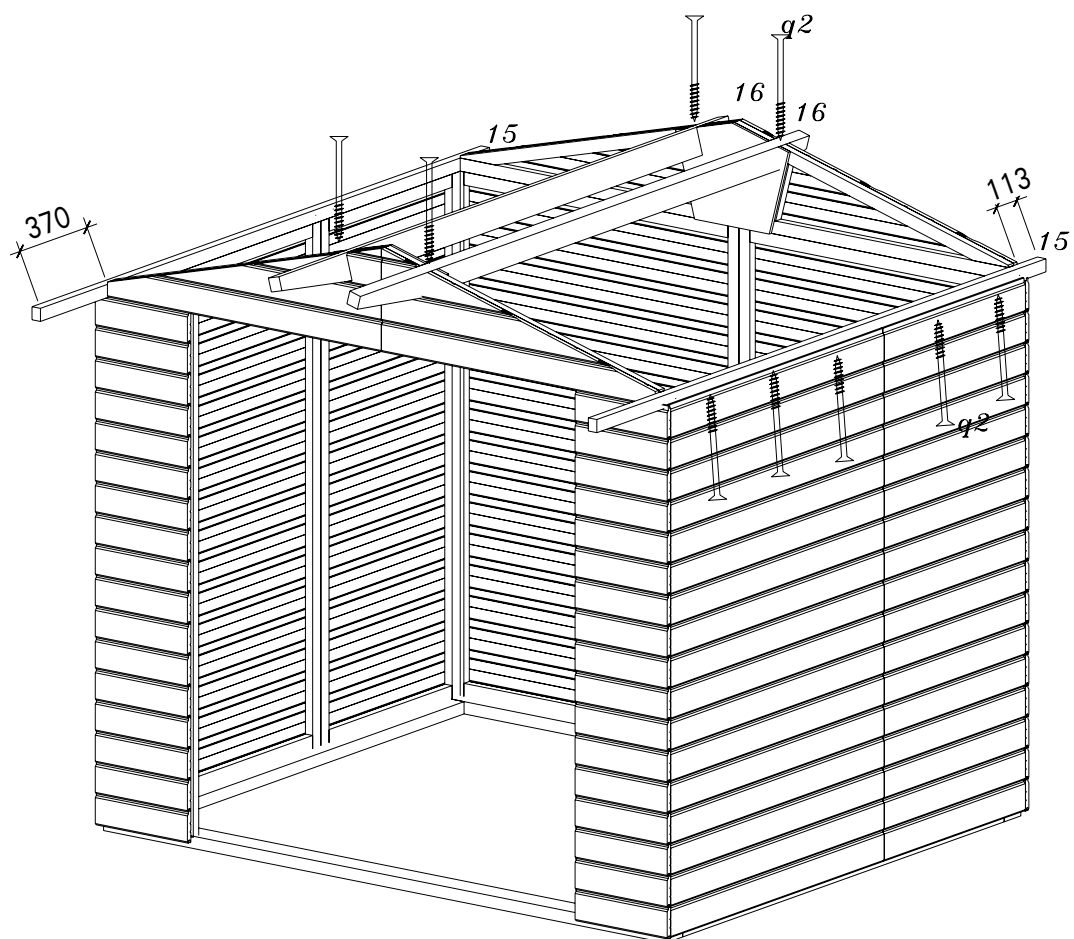
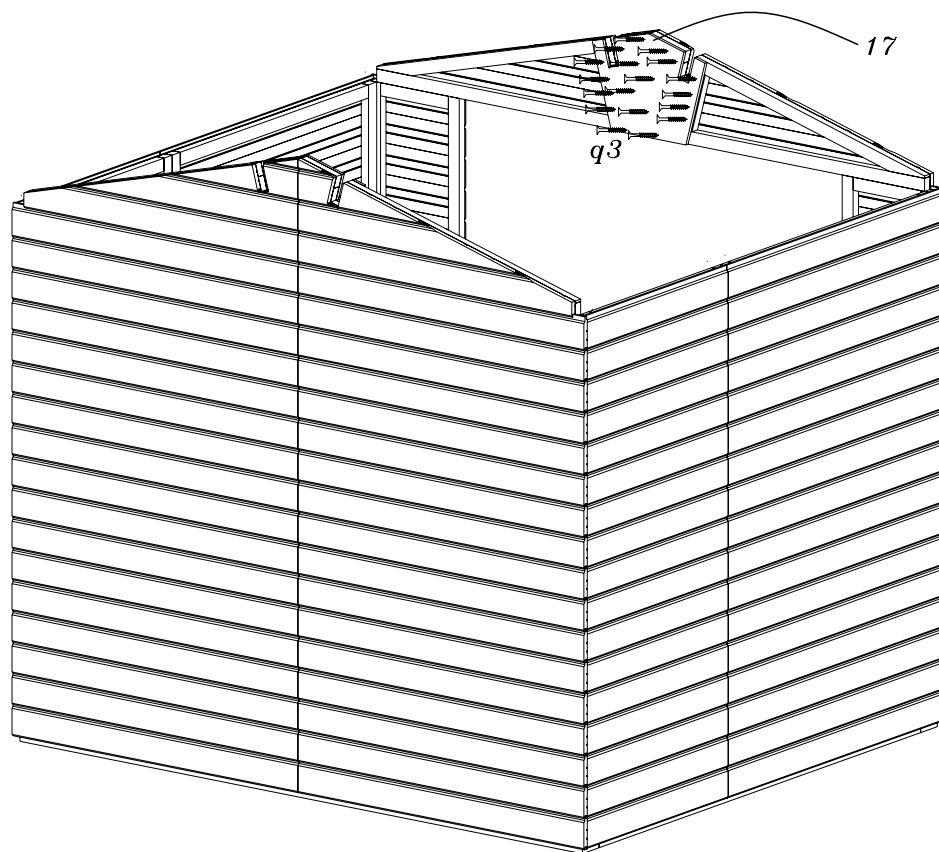

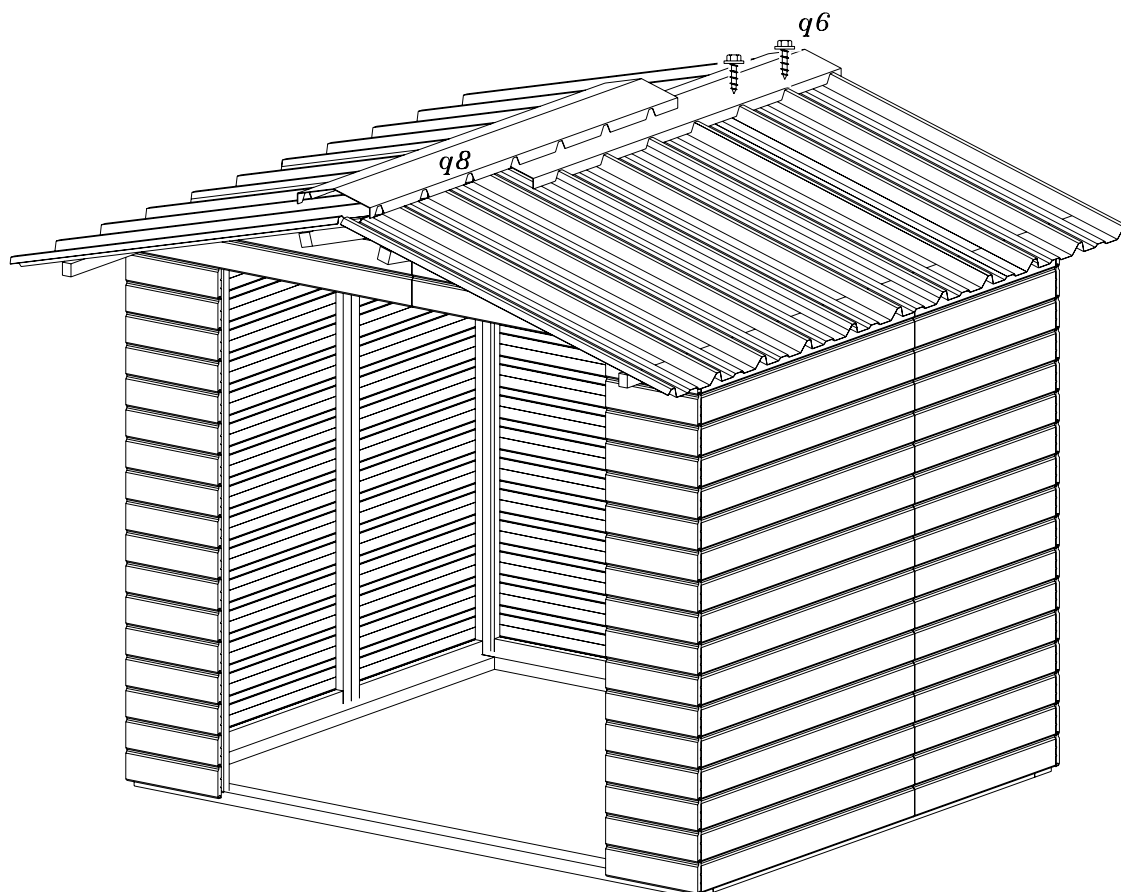
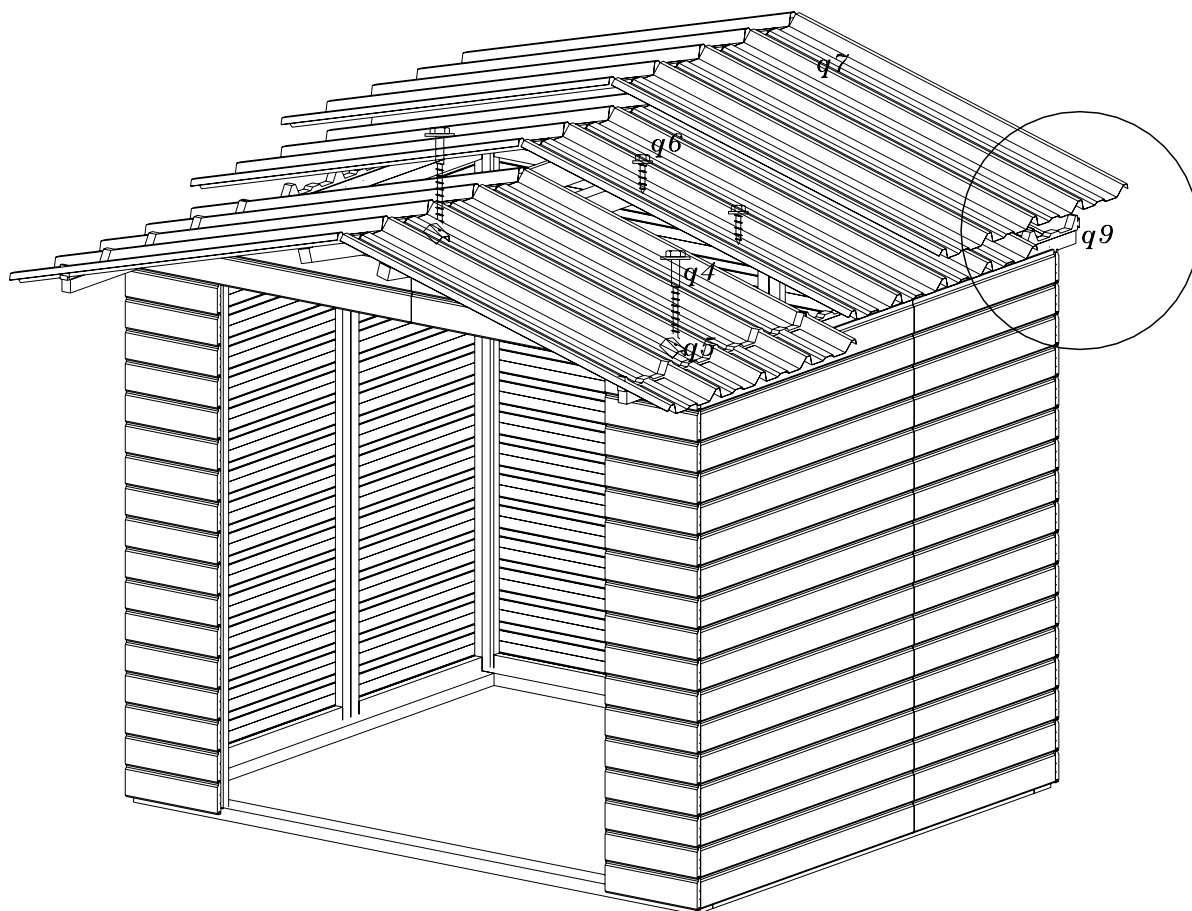

Ø12 mm
Ø8 mm

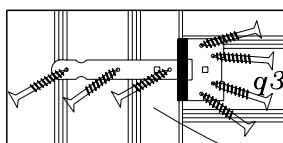
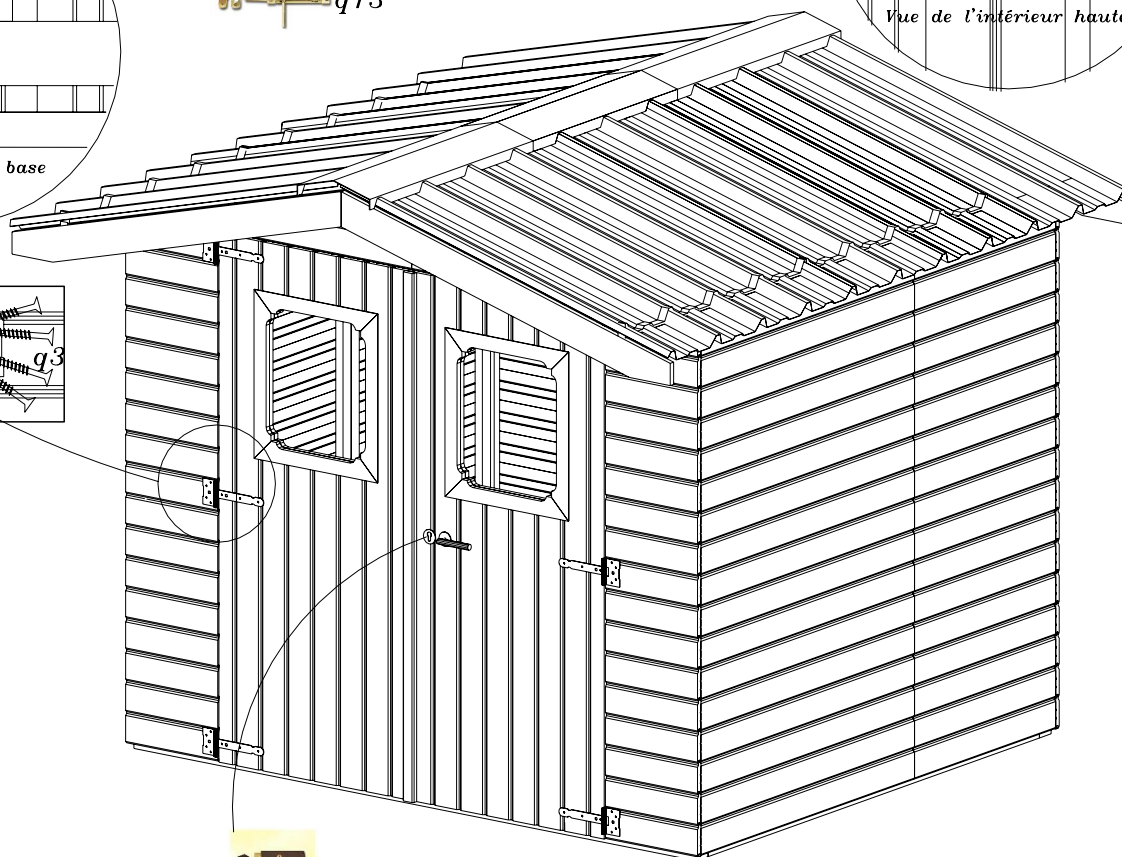
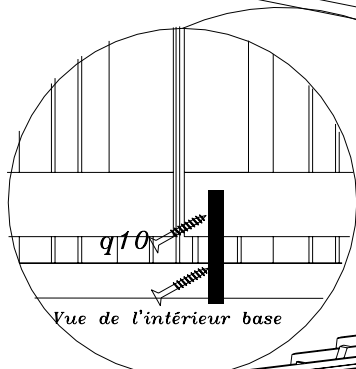
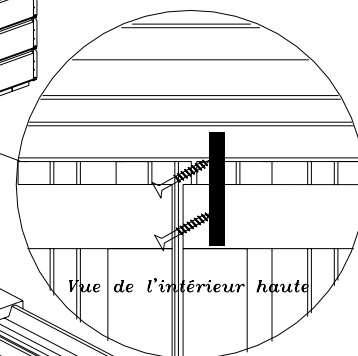
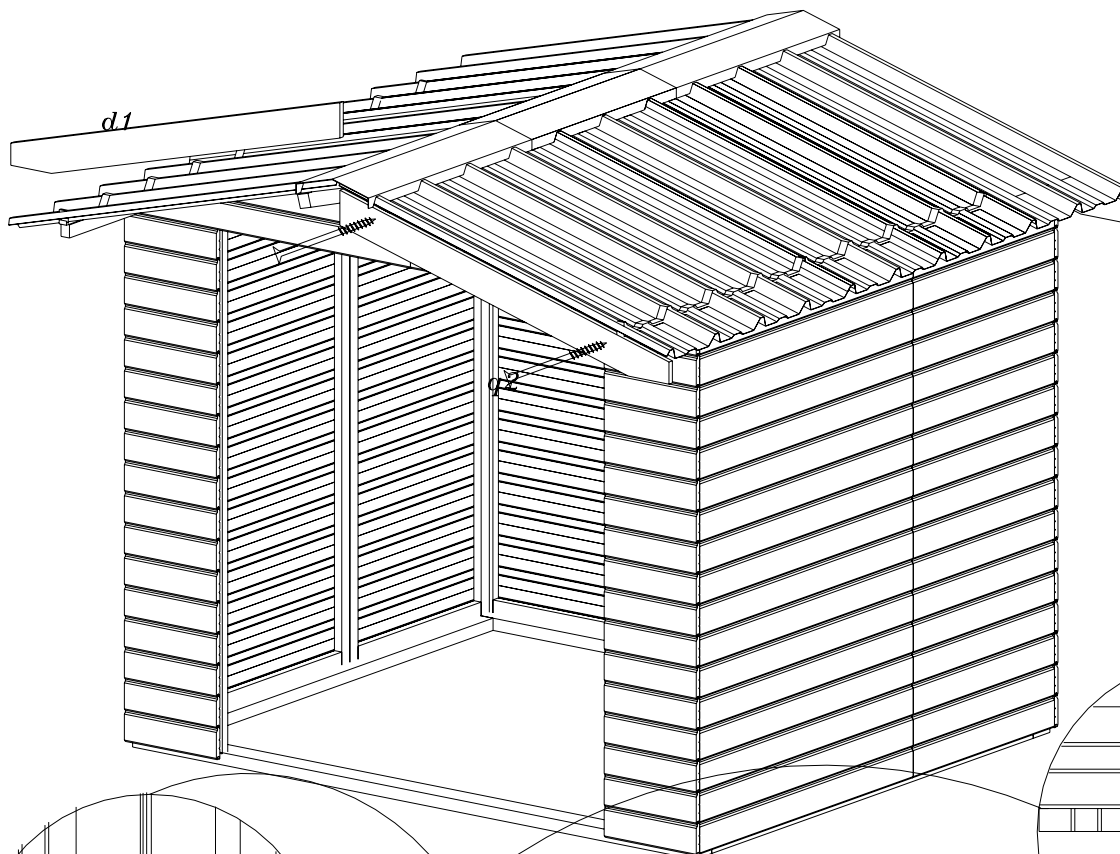

Ø3 mm

