

Elody
Art. Nr. 2846850
1/6

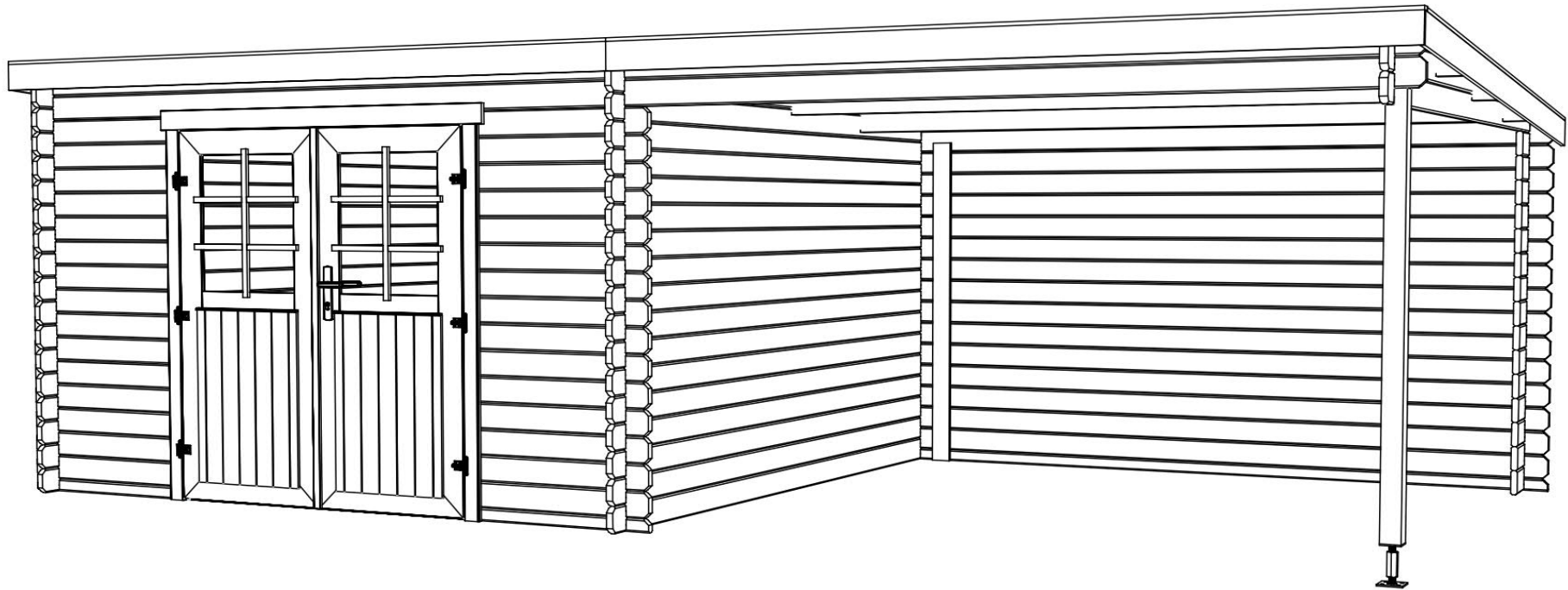

Art. Nr. 2846850

Groundplan - Grundplan - Plan de masse - Planimetria - Plattegrond -
Põhiplaan

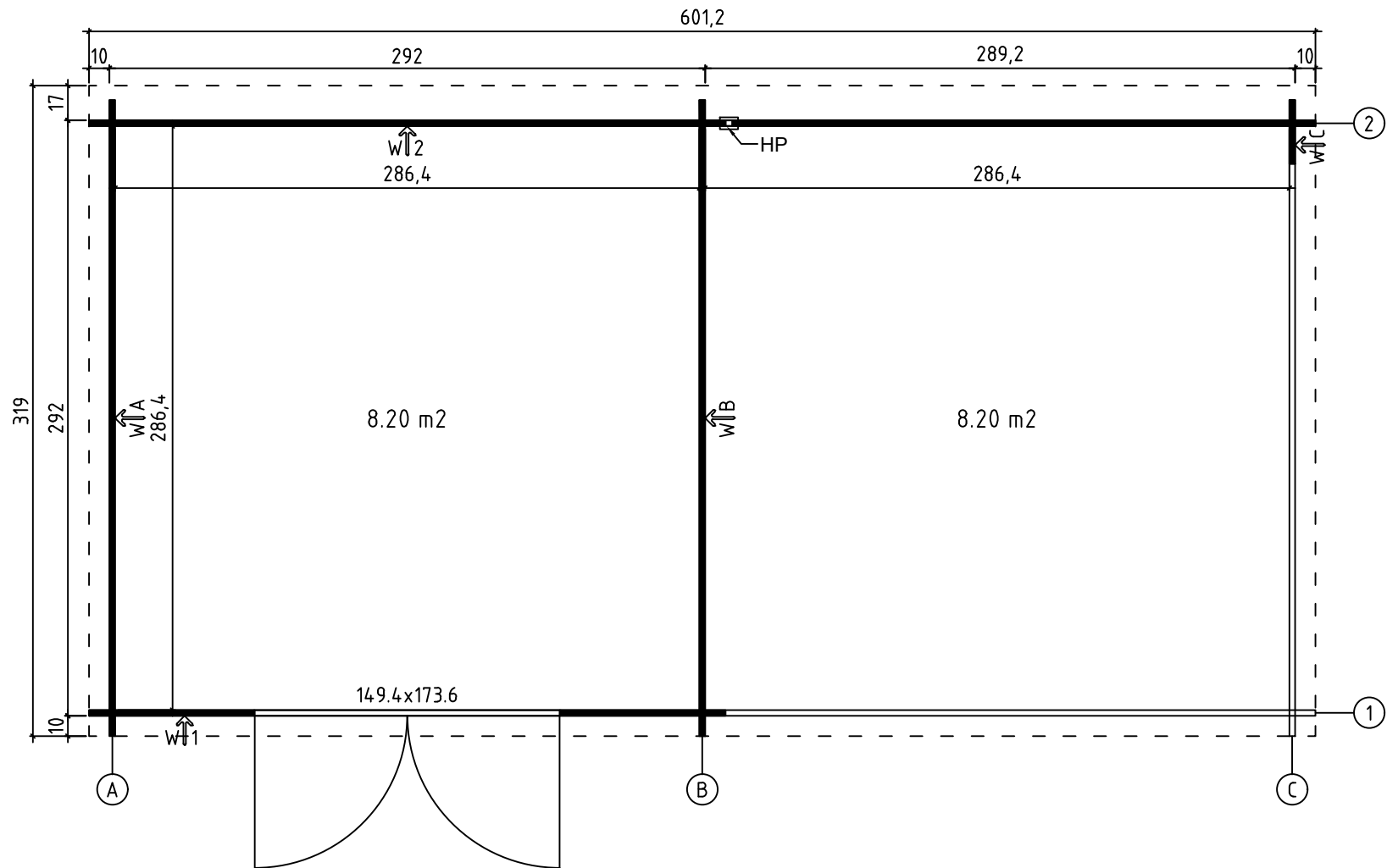





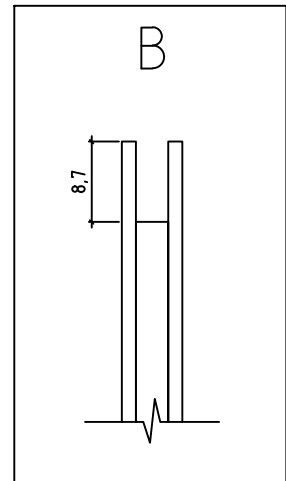
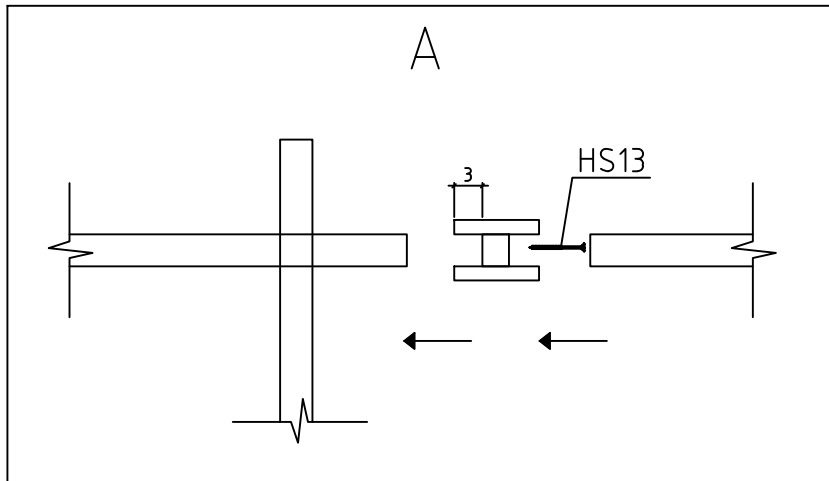
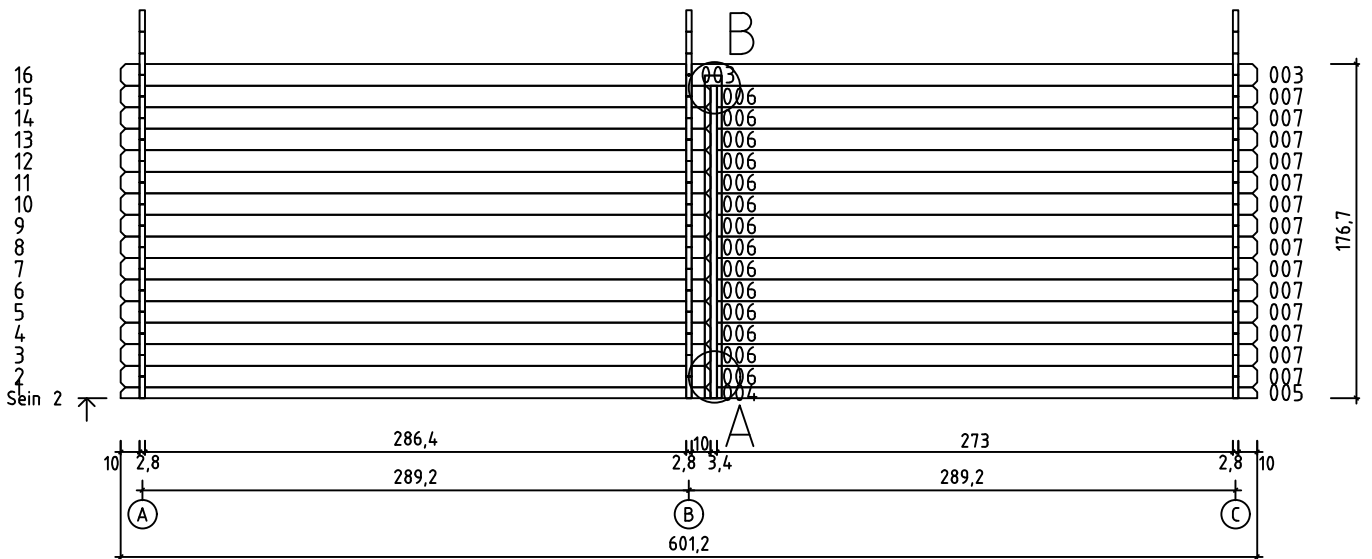
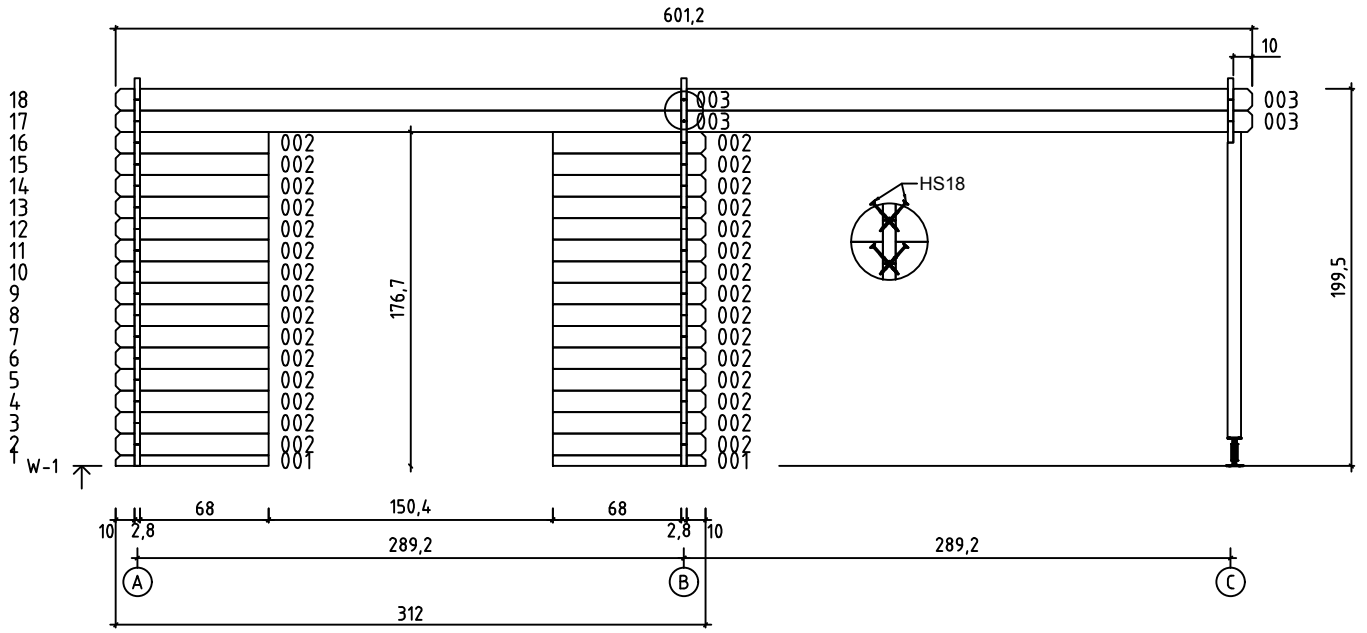



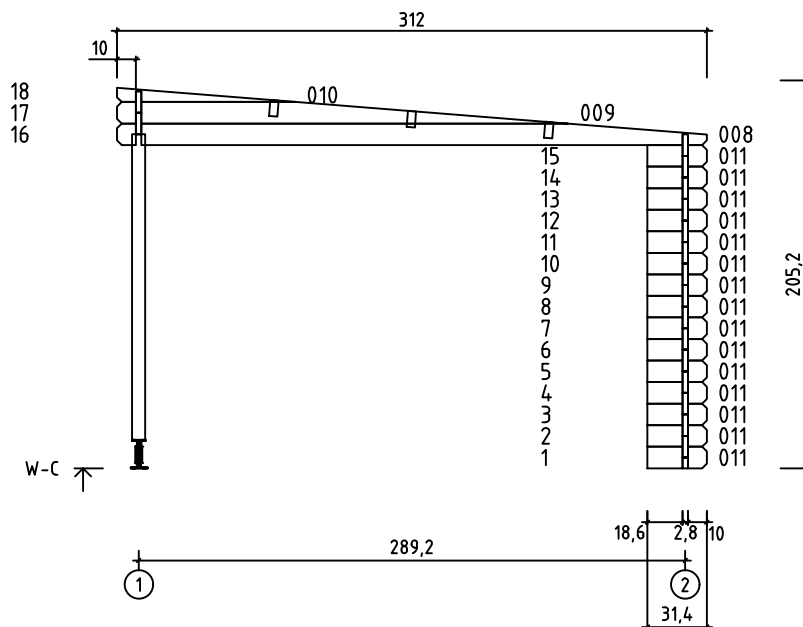
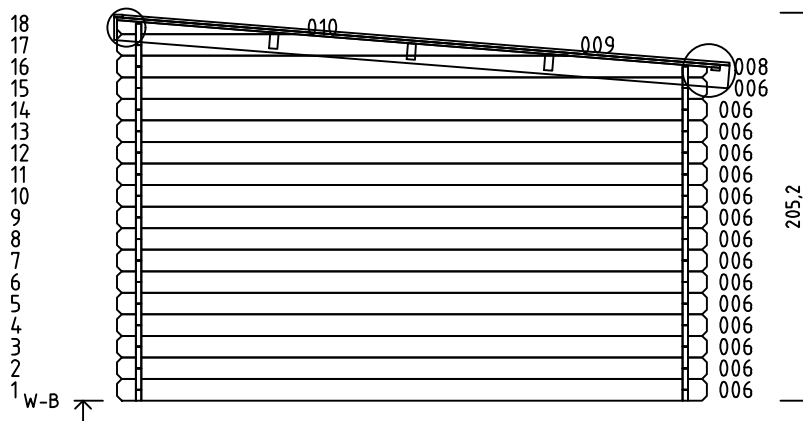
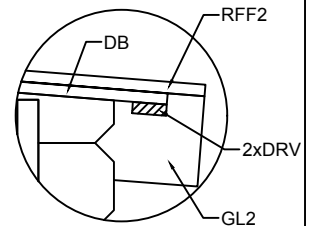
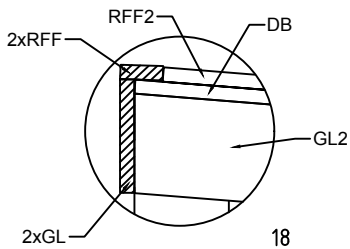
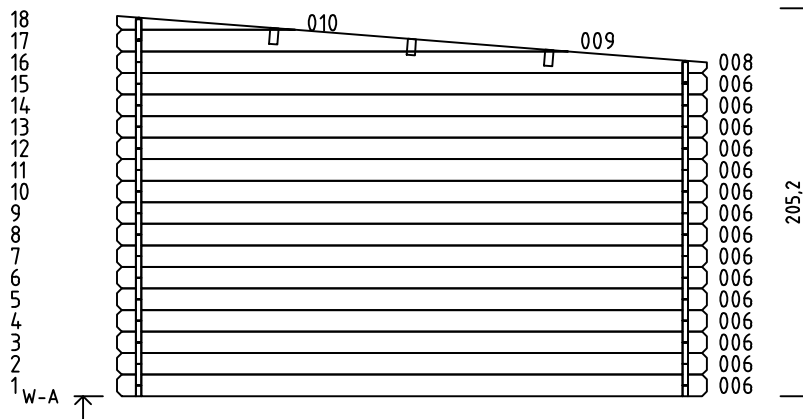

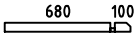
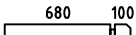
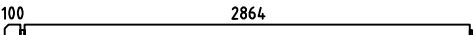
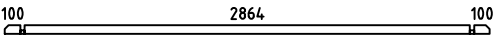
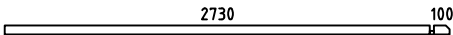
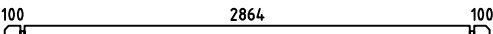
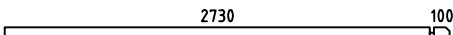
06.09.2019

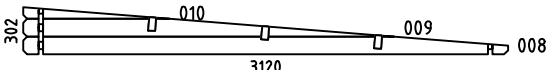
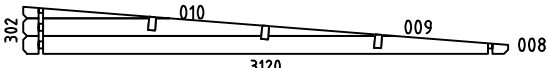
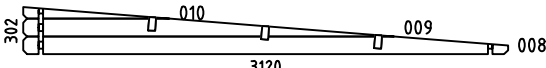
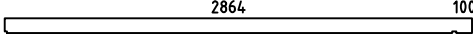
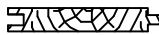
2/6

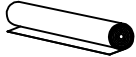
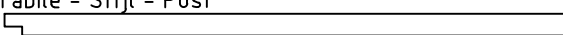

Art. Nr. 2846850

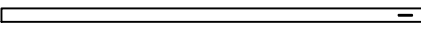

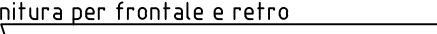
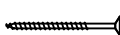
Pos	06.09.2019 Piece list - Stückliste - Liste des pièces - Elementi - Stuklijst - Tükítabel Art. Nr. 2846850	5/6	Q	P (mm)	L (mm)
001			2	28x57	808
002			30	28x114	808
003			6	28x114	3006
004			1	28x57	3120
005			1	28x57	2858
006			44	28x114	3120
007			14	28x114	2858
011			15	28x114	314
WA-1			1		
WB-1			1		
WC-1			1		
A-PR1	Roof beam - Dachbalken - Panne de toit - Perlina del tetto - Gordingen / dakbalk - Pärlin 		6	44x95	3006
DB	Roof boards - Dachbretter - Voliges - Perlina per tetto - Dakhout - Katuselaud 		67	90x15	3200
HP	H-profile - H-profilis - Profile H - Profilo ad H - H-profiel - H-profiil 		1	58x90	1700
RFF	Roofing felt fillet - Dachpappenleiste - Baguette de fixation du feutre bitumeux - Asse per fissaggio guaina bituminosa - Afdeklijst asfaltpapier - Katusepapiilist 		2	15x45	3021
RFF2	Roofing felt fillet - Dachpappenleiste - Baguette de fixation du feutre bitumeux - Asse per fissaggio guaina bituminosa - Afdeklijst asfaltpapier - Katusepapiilist 		2	15x45	3220
DPP-1	Roofing felt (strip) - Dachpappe (bahnen) - Feutre bitumeux (bande) - Cartone catramato - Asfaltpapier (baan) - Katusepapp 		4		6112
p	Post - Pfosten - Poteau - Piede registrabile - Stijl - Post 		1	70x70	1617
DRV	Roof edge reinforcement - Dachrandverstärkung - Corniere de renfort de bord de toit - Rinforzo x tetto - Dakrand versterking - Räästatugevdus 		2	15x45	3006
KFS-1	Storm protection - Sturmleiste - Latte anti-tempete - Protezione anti vento - Stormverankering / beveiliging - Tormikinnitusliist 		5	22x45	2050
GL	Gable moulding - Giebelleiste - Planche de rive - Finitura per frontale e retro del tetto - Gevellijst - Viilulaud 		2	15x120	3021
GL2	Gable moulding - Giebelleiste - Planche de rive - Finitura per frontale e retro del tetto - Gevellijst - Viilulaud 		2	15x120	3250
HS9	Screw for gable moulding - Schrauben für giebelleiste - Vis pour fixation planche de rive - Vite per fissare finiture davanti e dietro del tetto - Schroef voor gevellijst - Kruvi viilulauale 		32	3.5x50	

