

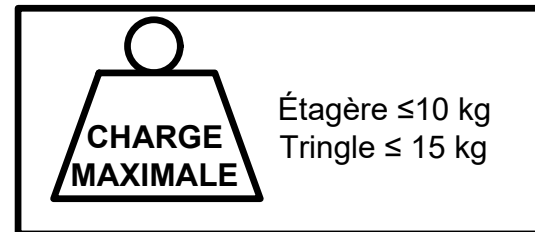

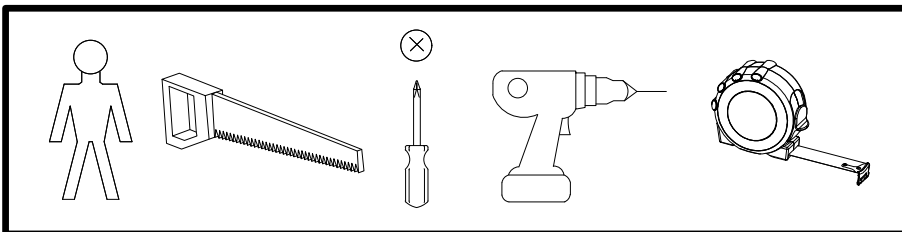

# HUGO

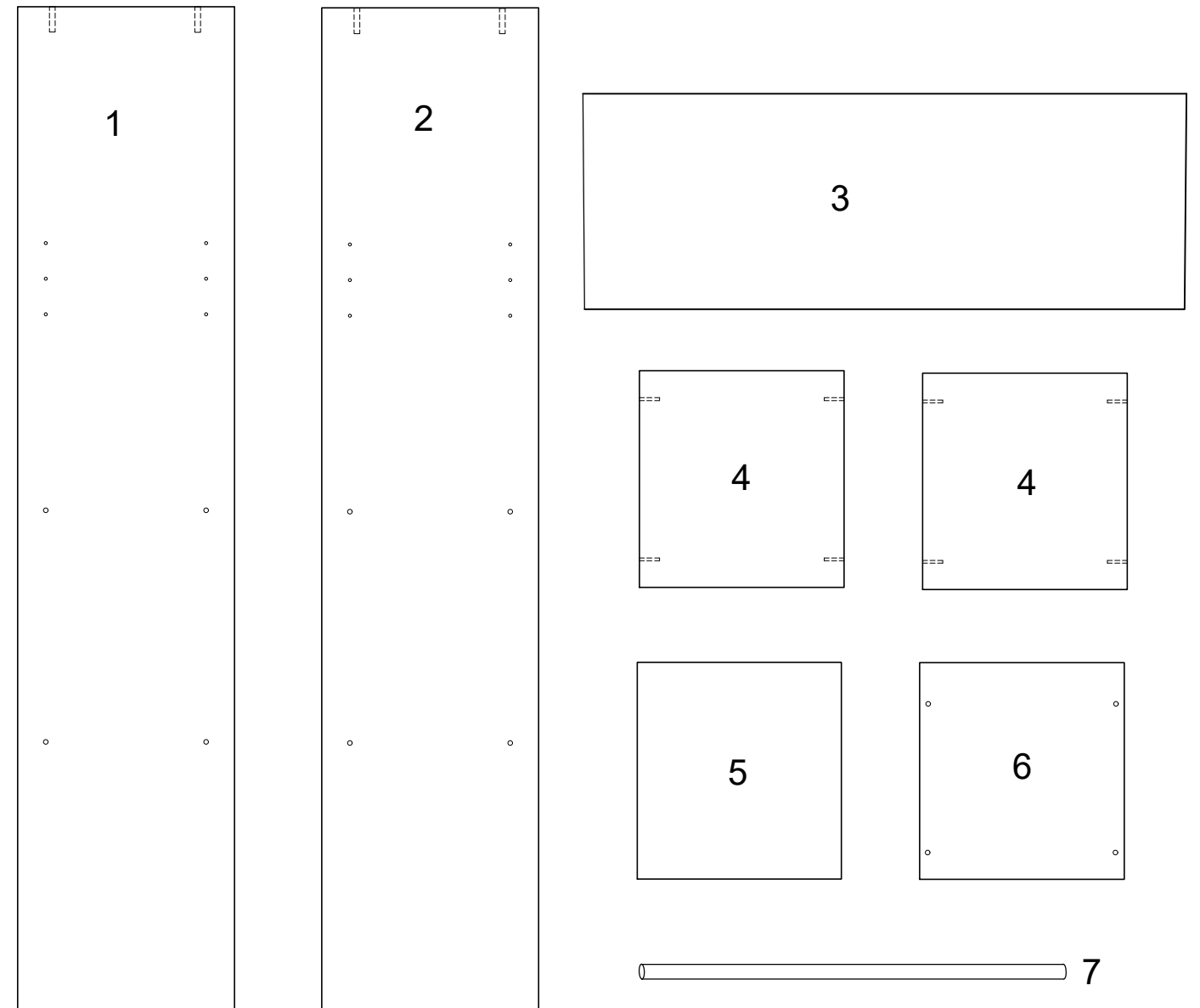
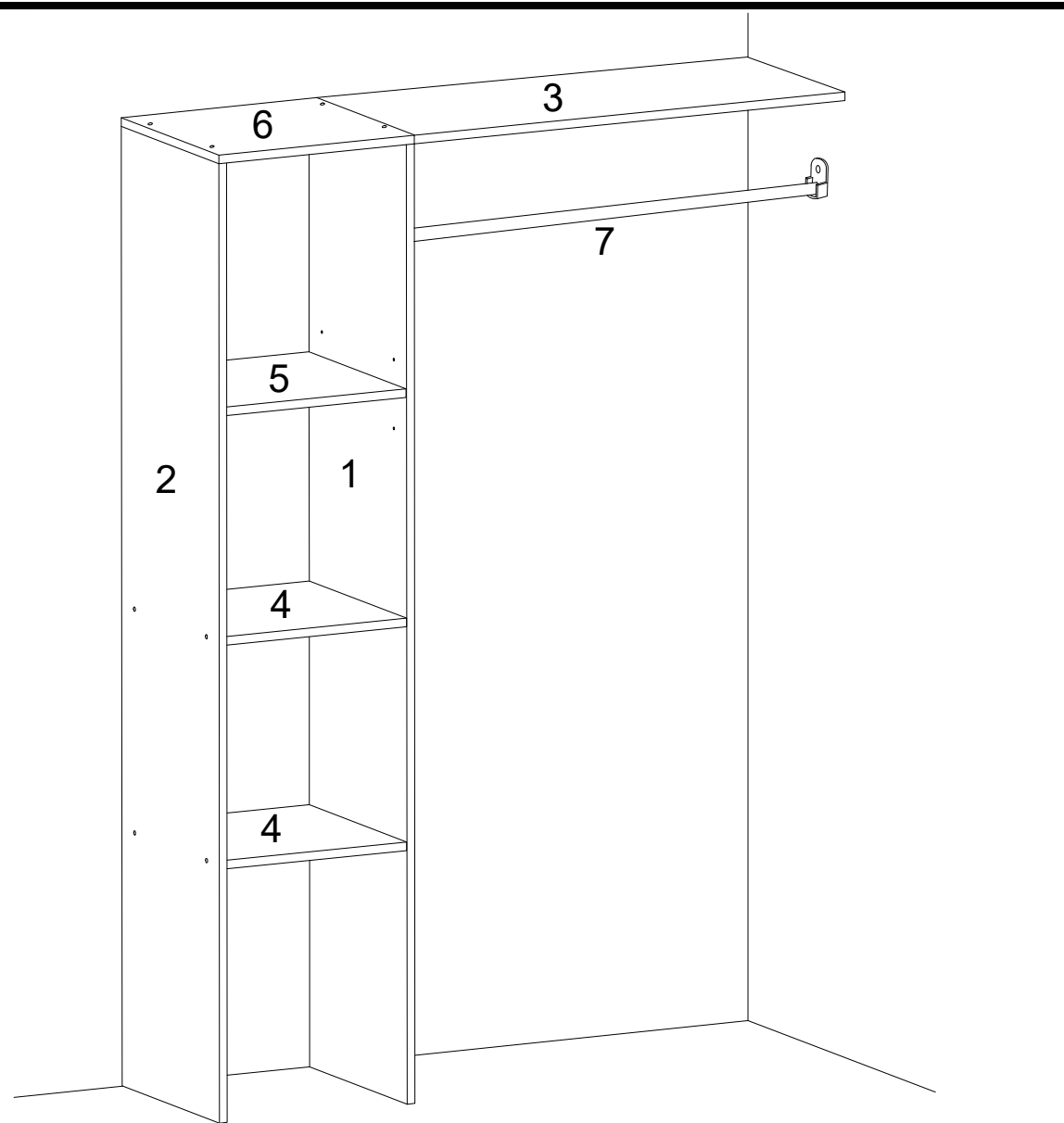

**!**  
*L'information important*  
 Conservez cet information avec les meubles pour référence à l'avenir

**ATTENTION**  
 Le basculement du meuble peut entraîner des blessures graves. Pour éviter le basculement du meuble, fixez le meuble au mur à l'aide de fixations appropriées \*. Évitez l'ouverture rapide et forte des tiroirs. Veiller à suivre les consignes de montage et de fixation du tiroir et des coulisses afin d'éviter tous risques de chute comme mentionné dans la notice jointe.

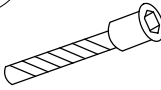
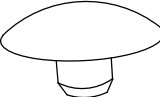
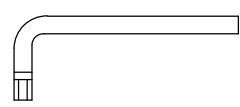
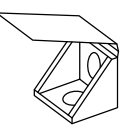
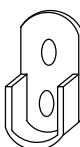
*\*Les pièces de fixation non incluses. Les fixations doivent être adaptées au matériau spécifique du mur. Consultez-vous avec le spécialiste pour obtenir des conseils et le choix des fixations adaptées à votre mur.*

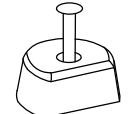
<b>B</b>  x9 3,5x15	<b>D</b>  x12 7x50	<b>E</b>  x8	<b>F</b> 	<b>J</b>  x5
<b>M</b>  x2	<b>N</b>  x4	<b>K</b>  x1		

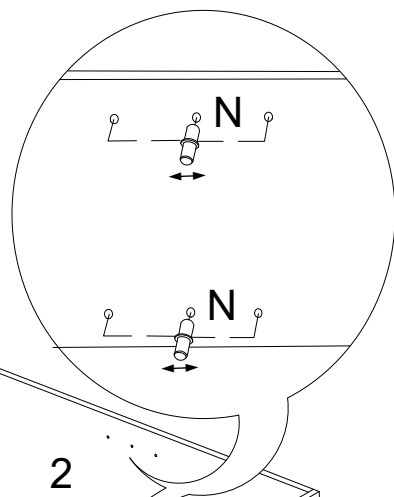
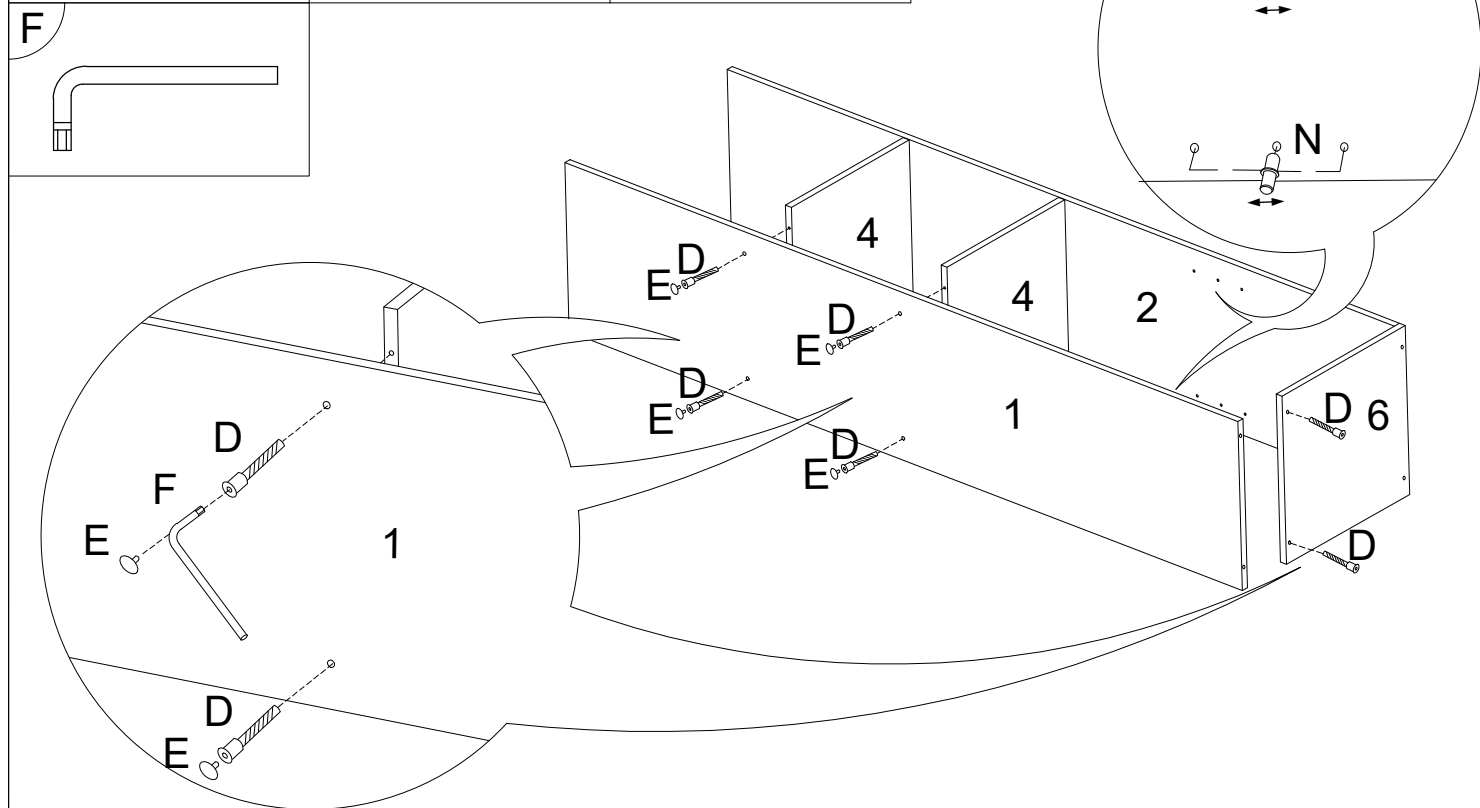
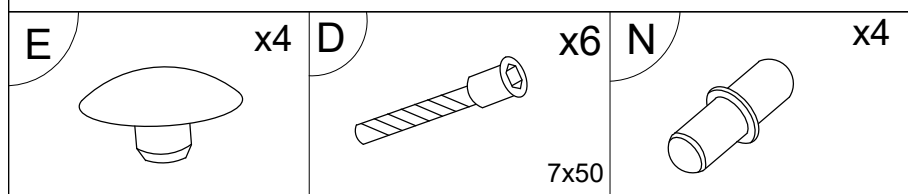
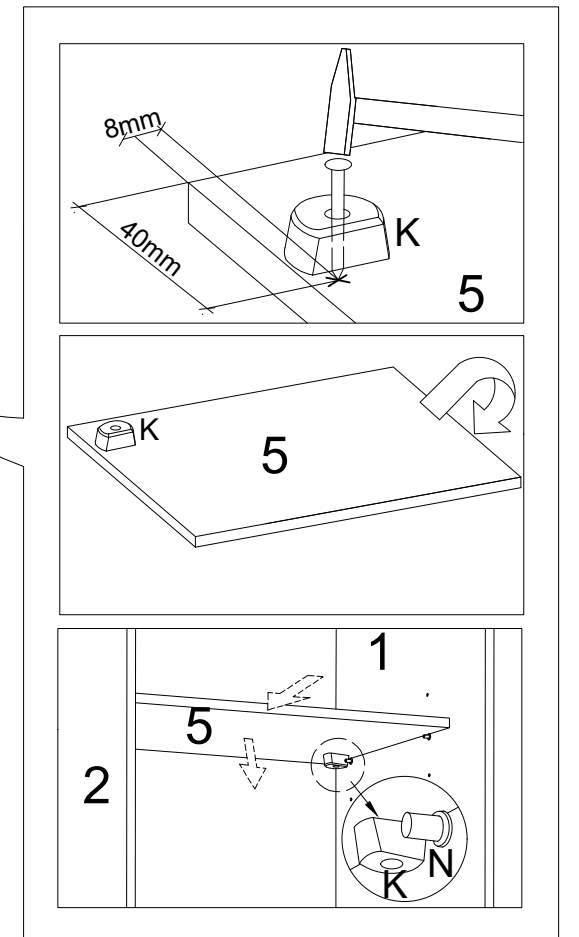
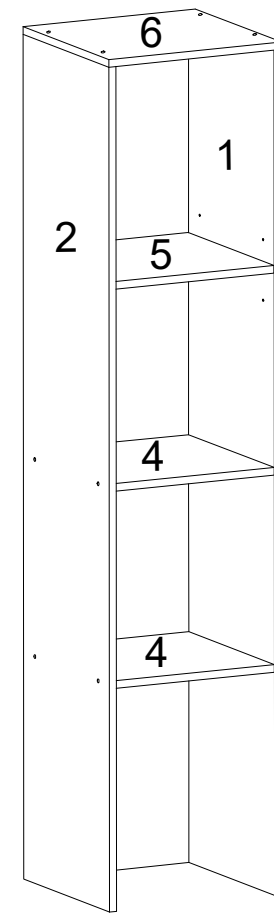
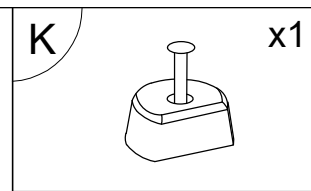
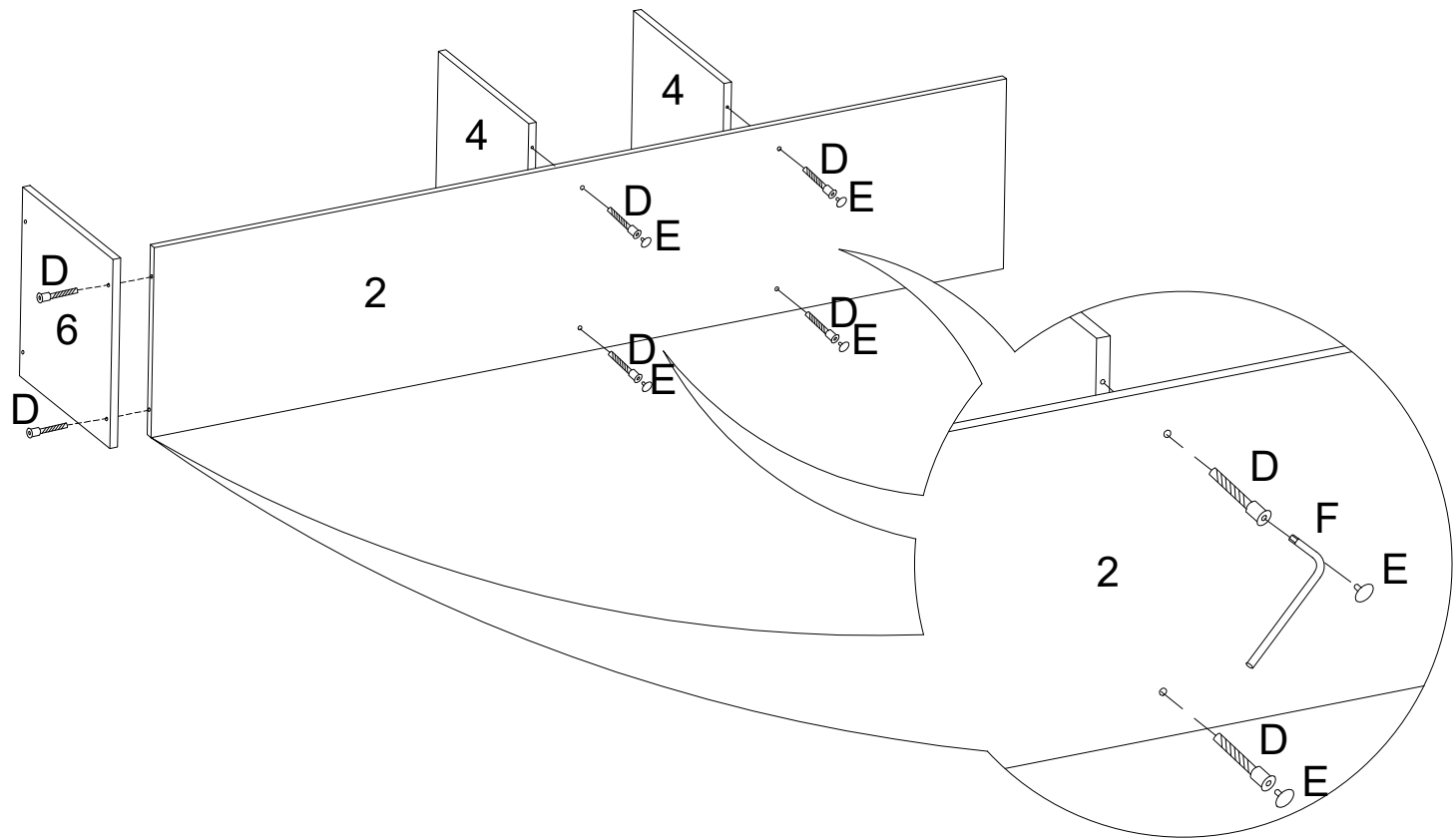
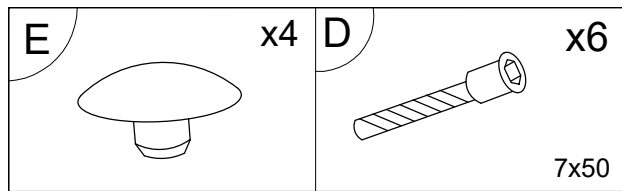

**OPTION A**  
*IMAGES 7-8*

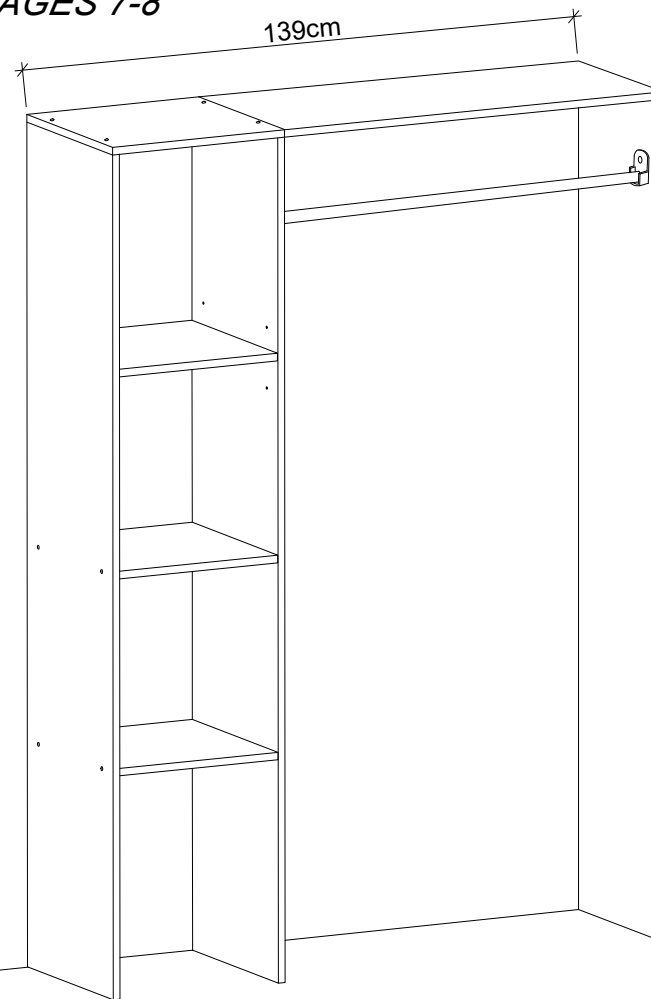

**OPTION B**  
*IMAGES 9-10*

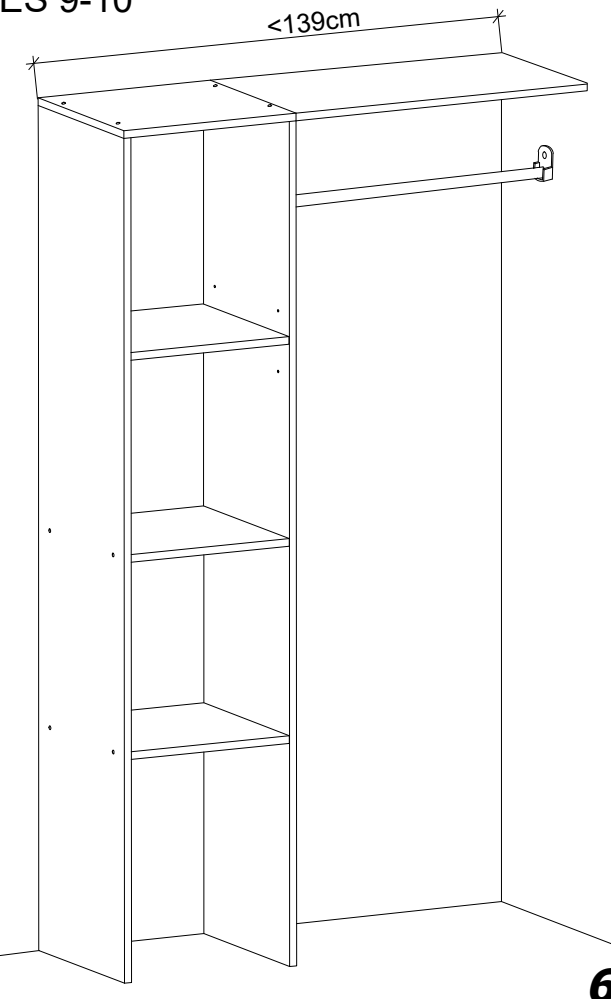

**5**

**6**

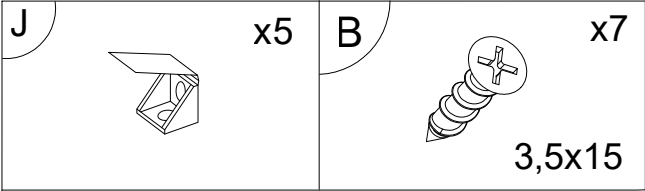

OPTION A

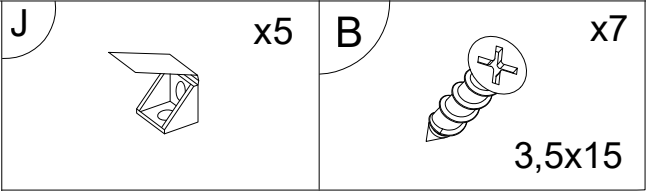
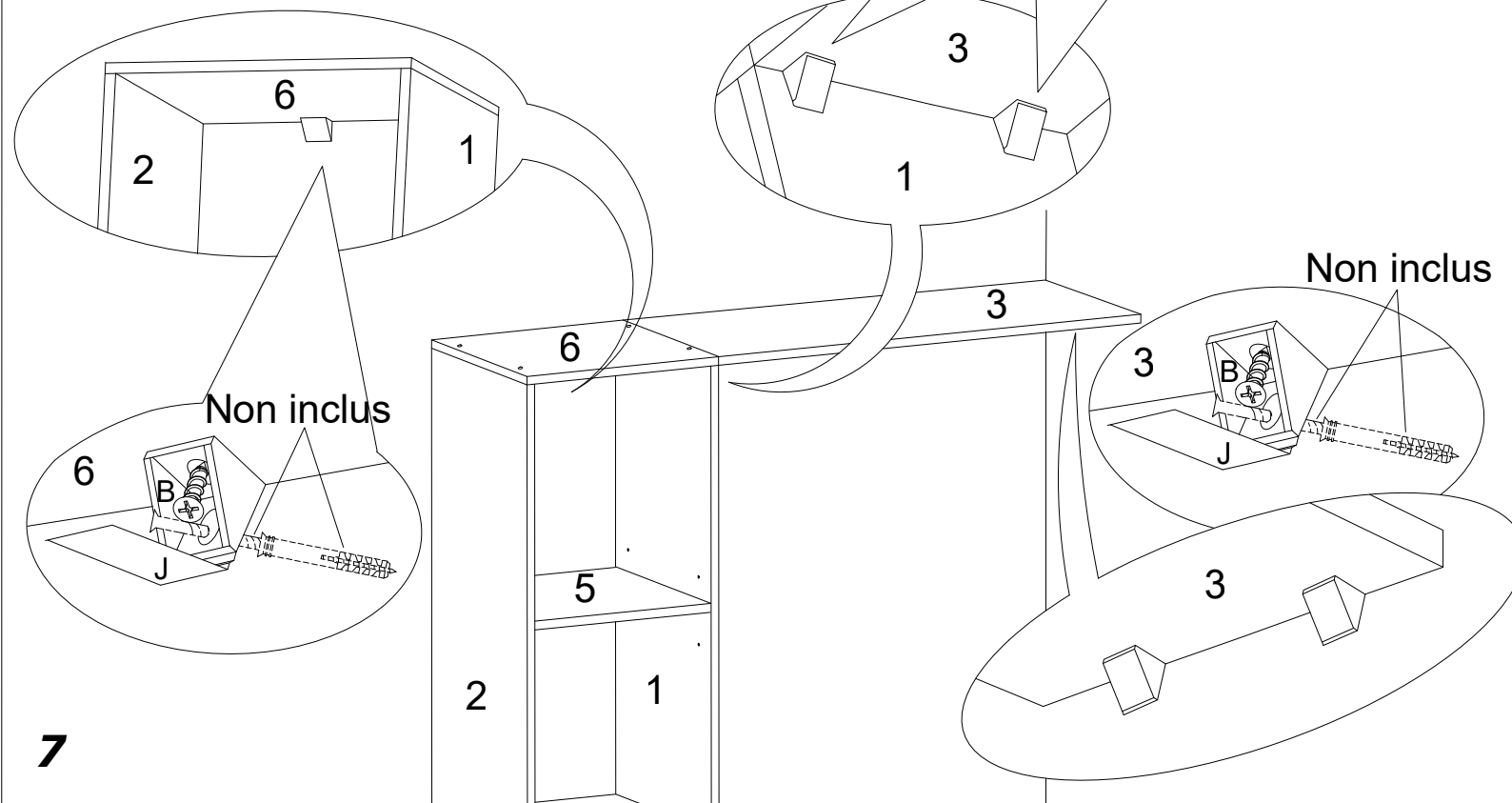

OPTION B

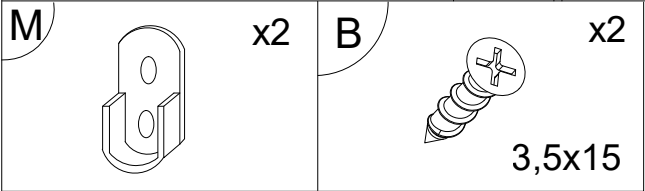
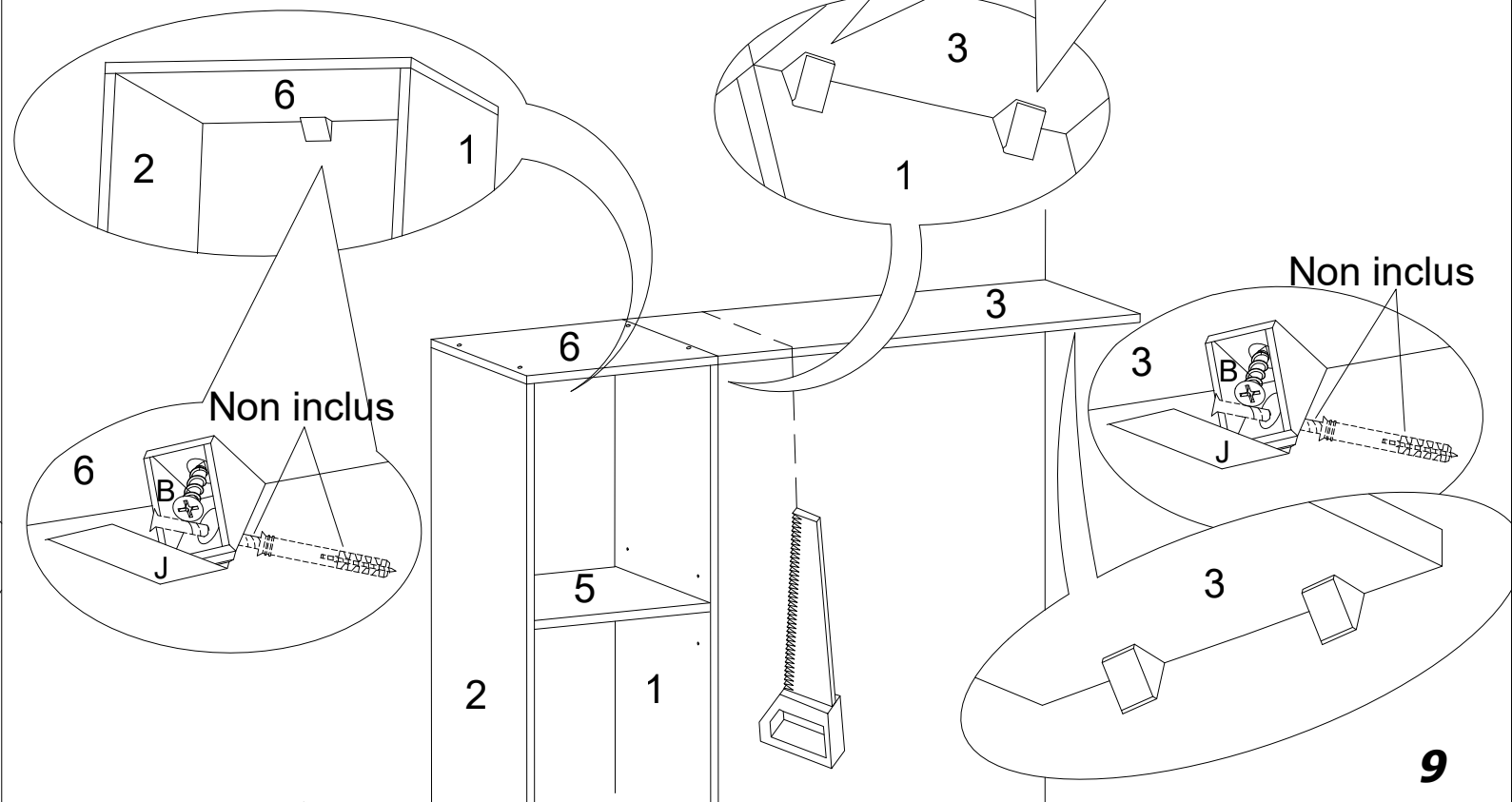

OPTION A

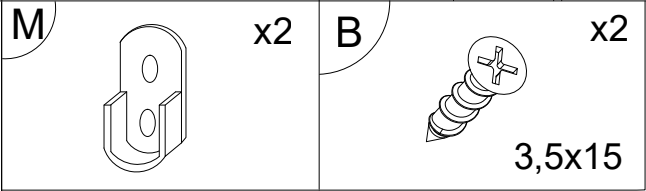
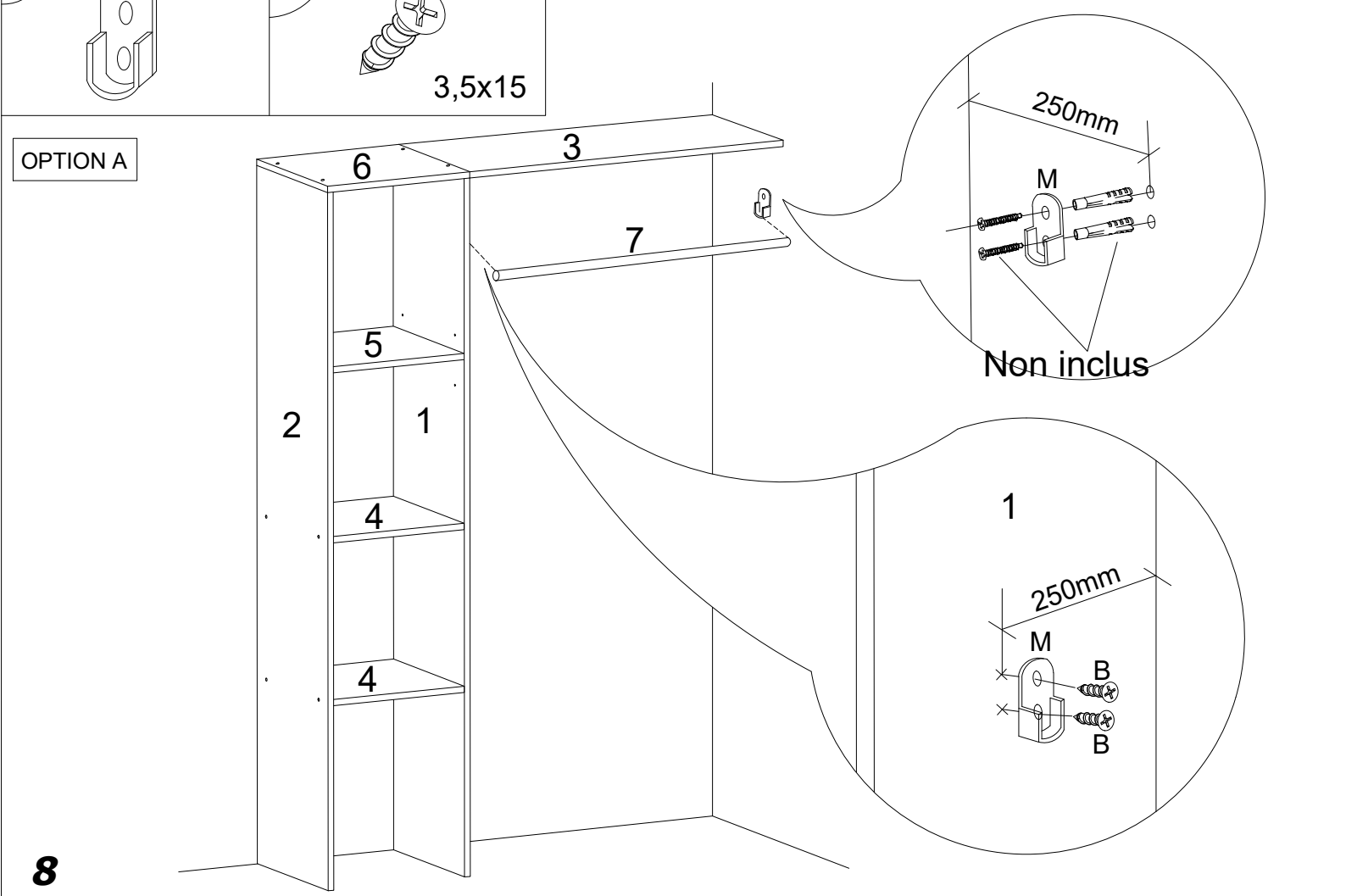

OPTION B

